

APAVISA

SOLID

2 cm

2022

APAVISA

Applications	02	
Installations systems	03	
Collections	Pictures	Pieces
Lamiere	06	65
MEtoDO	08	66
Hutton	10	68
Fire	14	68
Emotion	16	70
Karacter	18	71
Wind	20	72
Aquarela	22	73
North	24	74
Orobico Red	32	76
Zinc	34	76
Tattoo	36	77
Rellik	38	78
Equinox	40	80
Junoon	42	80
Object	46	82
Senso	50	83
Materia	52	84
Concept	58	86
Price list	88	
Adjustable system	88	
Technical characteristics	90	
Packing list	91	



Entrances / Entradas



Terraces / Terrazas



Gardens / Jardines



Pools / Piscinas



**Public spaces /
Espacios públicos**



**Industrial areas /
Espacios industriales**

Raised floor / Suelo sobreelevado



Our SOLID 2CM tiles can be easily installed on raised floor systems to provide drainage of rain water. Just ensure that the area to be installed is leveled, compact and can support the weight.

Los productos SOLID 2CM son fácilmente instalables en sistemas de suelo sobreelevado para el drenaje de agua. Sólo hay que tener un area nivelada, compacta y que pueda soportar el peso de la instalación.

On gravel or sand / Sobre grava o arena



Make sure your ground is compact and leveled. Install them as desired giving a generous joint between SOLID 2CM tiles.

Asegurate que el suelo está nivelado y compactado. Instala las baldosas SOLID 2CM como gustes, dando una junta generosa.

On grass / Sobre cesped



As easy as it seems. Carve about 2 inches of soil and pour some gravel to make a proper bed. Then lay your SOLID 2CM products on top of it.

Tan fácil como parece. Rebaja aproximadamente 4cm y vierte algo de grava para formar un buen lecho. Después posiciona las piezas SOLID 2CM encima.

Adhesive / Con adhesivos



Install your SOLID 2CM products as ordinary tiles. No special instructions are needed.

Instala tus baldosas SOLID 2CM como cualquier otra. No requiere conocimientos específicos.



SOLID
2 cm



SOLID
2 cm





SOLID
2 cm



SOLID
2 cm



SOLID
2 cm

SOLID
2 cm







SOLID
2 cm





SOLID
2 cm









SOLID
2 cm





SOLID
2 cm



SOLID
2 cm







SOLID
2 cm



SOLID
2 cm



SOLID
2 cm







SOLID
2 cm





SOLID
2 cm



SOLID
2 cm
2021



Lamiere Blue Solid 2 cm

G-9234



Lamiere White Solid 2 cm

G-9234

DIN
R11

DIN 51130

CLASS
C

DIN 51097

DCOF
> 0.42

ANSI A137.1 S-9.6.1

PTV
> 36
LOW SLIP
POTENTIAL

BS EN 13036-4

CLASE
3

UNE-ENV 12633



MEtoDO Grey Solid 2 cm

G-9234



MEtoDO Ivory Solid 2 cm

G-9234



MEtoDO Grana Solid 2 cm

G-9234

DIN
R11

DIN 51130

CLASS
C

DIN 51097

DCOF
> 0.42

ANSI A137.1 S-9.6.1

PTV
> 36
LOW SLIP
POTENTIAL

BS EN 13036-4

CLASE
3

UNE-ENV 12633



Hutton Rosso Solid 2 cm

G-9234



Fire Multicolor Solid 2 cm

G-9234



Fire Rosso Solid 2 cm

G-G-9234

DIN
R11

DIN 51130

CLASS
C

DIN 51097

DCOF
> 0.42

ANSI A137.1 S-9.6.1

PTV
> 36
LOW SLIP
POTENTIAL

BS EN 13036-4

CLASE
3

UNE-ENV 12633



Emotion Grey Solid 2 cm



G-9234



Karacter Multicolor Solid 2 cm



G-9234



DIN 51130

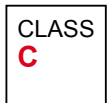

DIN 51097



ANSI A137.1 S-9.6.1

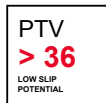

BS EN 13036-4

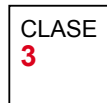

UNE-ENV 12633



Wind Grey Solid 2 cm

G-9234



Wind Ivory Solid 2 cm

G-9234



Aquarela Solid 2 cm

G-9234

DIN
R11

DIN 51130

CLASS
C

DIN 51097

DCOF
> 0.42

ANSI A137.1 S-9.6.1

PTV
> 36
LOW SLIP
POTENTIAL

BS EN 13036-4

CLASE
3

UNE-ENV 12633



North Grey Solid 2 cm

G-9234



North Sand Solid 2 cm

G-9234



North Sand Decor Solid 2 cm

G-9234



North Patchwork Solid 2 cm

G-9234

DIN
R11

DIN 51130

CLASS
C

DIN 51097

DCOF
> 0.42

ANSI A137.1 S-9.6.1

PTV
> 36
LOW SLIP
POTENTIAL

BS EN 13036-4

CLASE
3

UNE-ENV 12633



Orobico Red Solid 2 cm

G-9234

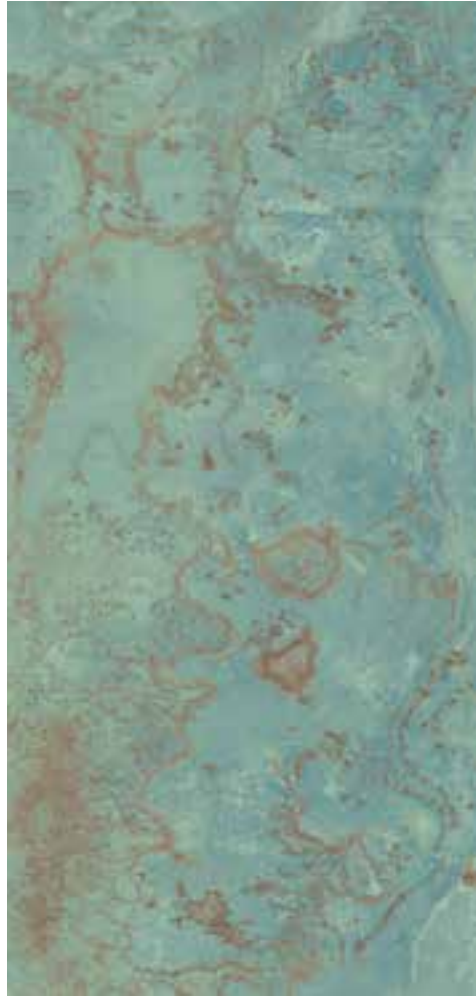

Zinc Green Solid 2 cm

G-9234



Tatto Black Solid 2 cm

G-9234

DIN
R11

DIN 51130

CLASS
C

DIN 51097

DCOF
> 0.42

ANSI A137.1 S-9.6.1

PTV
> 36
LOW SLIP
POTENTIAL

BS EN 13036-4

CLASE
3

UNE-ENV 12633



Rellik Biege Natural Solid 2 cm

G-9234



Rellik Grey Natural Solid 2 cm

G-9234



Rellik White Natural Solid 2 cm

G-9234

DIN
R11

DIN 51130

CLASS
C

DIN 51097

DCOF
> 0.42

ANSI A137.1 S-9.6.1

PTV
> 36
LOW SLIP
POTENTIAL

BS EN 13036-4

CLASE
3

UNE-ENV 12633



Equinox Grey Solid 2 cm

G-9234

Junoon Beige Solid 2 cm

G-9234

Junoon Maple Solid 2 cm

G-9234

DIN
R11

DIN 51130

CLASS
C

DIN 51097

DCOF
> 0.42

ANSI A137.1 S-9.6.1

PTV
> 36
LOW SLIP
POTENTIAL

BS EN 13036-4

CLASE
3

UNE-ENV 12633



Object White Solid 2 cm

G-9234



Object Grey Solid 2 cm

G-9234



Senso Green Solid 2 cm

G-9234

DIN
R11

DIN 51130

CLASS
C

DIN 51097

DCOF
> 0.42

ANSI A137.1 S-9.6.1

PTV
> 36
LOW SLIP
POTENTIAL

BS EN 13036-4

CLASE
3

UNE-ENV 12633



Materia White Solid 2 cm

G-9234



Materia Grey Solid 2 cm

G-9234



Materia Beige Solid 2 cm

G-9234



DIN 51130

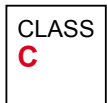

DIN 51097



ANSI A137.1 S-9.6.1

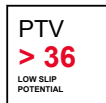

BS EN 13036-4

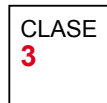

UNE-ENV 12633



Concept Anthracite Solid 2 cm

G-9234



Concept Grey Solid 2 cm

G-9234



Concept Beige Solid 2 cm

G-9234

DIN
R11

DIN 51130

CLASS
C

DIN 51097

DCOF
> 0.42

ANSI A137.1 S-9.6.1





PTV
> 36
LOW SLIP
POTENTIAL



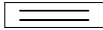

BS EN 13036-4

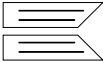
CLASE
3

UNE-ENV 12633

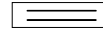
Price list / Lista de precios

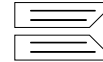
	 solid 2cm serie 50x100 (49,75 x 99,55 cm - 19,59" x 39,19")	 solid 2cm serie drain 25x100 (24,51 x 99,55 cm - 9,65" x 39,19")	 solid 2cm serie drain angle 25x25 (24,51 x 24,51 cm - 9,65" x 9,65")	 solid 2cm serie drain diagonal 25x100 (24,51 x 99,55 cm - 9,65" x 39,19")	 solid 2cm serie peldaño "L" 50x100 (44 x 99,55 cm - 17,32" x 39,19")
Fire Rosso solid 2 cm	G-9234	G-6471	G-6187	G-6471	G-6623
Fire Multicolor Solid 2 cm	G-9234	-	-	-	G-6623
Emotion Grey solid 2 cm	G-9234	G-6471	G-6187	G-6471	G-6623
Karakter Multicolor solid 2 cm	G-9234	-	-	-	G-6623
Wind Grey solid 2 cm	G-9234	G-6471	G-6187	G-6471	G-6623
Wind Ivory Solid 2 cm	G-9234	G-6471	G-6187	G-6471	G-6623
Aquarela Red solid 2 cm	G-9234	G-6471	G-6187	G-6471	G-6623
North Grey solid 2 cm	G-9234	G-6471	G-6187	G-6471	G-6623
North Sand Solid 2 cm	G-9234	G-6471	G-6187	G-6471	G-6623
North Sand Decor solid 2 cm	G-9234	-	-	-	G-6623
North Patchwork Solid 2 cm	G-9234	-	-	-	G-6623
Orobico Red solid 2 cm	G-9234	G-471	G-187	G-471	G-623
Zinc Green solid 2 cm	G-9234	G-471	G-187	G-471	G-623
Tattoo Black solid 2 cm	G-9234	G-471	G-187	G-471	G-623
Lamiere Blue solid 2 cm	G-9234	G-471	G-187	G-471	G-623
Lamiere White solid 2 cm	G-9234	G-471	G-187	G-471	G-623
St.Vincent solid 2 cm	G-9234	G-471	G-187	G-471	G-623

	 solid 2cm serie 50x100 (49,75 x 99,55 cm - 19,59" x 39,19")	 solid 2cm serie drain 25x100 (24,51 x 99,55 cm - 9,65" x 39,19")	 solid 2cm serie drain angle 25x25 (24,51 x 24,51 cm - 9,65" x 9,65")	 solid 2cm serie drain diagonal 25x100 (24,51 x 99,55 cm - 9,65" x 39,19")	 solid 2cm serie peldaño "L" 50x100 (44 x 99,55 cm - 17,32" x 39,19")
Equinox Grey solid 2 cm	G-9234	G-471	G-187	G-471	G-623
Junoon Beige solid 2 cm	G-9234	G-471	G-187	G-471	G-623
Junoon Maple solid 2 cm	G-9234	G-471	G-187	G-471	G-623
Object White solid 2 cm	G-9234	G-471	G-187	G-471	G-623
Object Grey solid 2 cm	G-9234	G-471	G-187	G-471	G-623
Sybarum Black solid 2 cm	G-9234	G-471	G-187	G-471	G-623
Sybarum Beige solid 2 cm	G-9234	G-471	G-187	G-471	G-623
Materia White solid 2 cm	G-9234	G-471	G-187	G-471	G-623
Materia Grey solid 2 cm	G-9234	G-471	G-187	G-471	G-623
Materia Beige solid 2 cm	G-9234	G-471	G-187	G-471	G-623
MEtoDo Grey solid 2 cm	G-9234	G-471	G-187	G-471	G-623
MEtoDo Ivory solid 2 cm	G-9234	G-471	G-187	G-471	G-623
MEtoDo Grana solid 2 cm	G-9234	G-471	G-187	G-471	G-623
Concept Anthracite solid 2 cm	G-9234	G-471	G-187	G-471	G-623
Concept Grey solid 2 cm	G-9234	G-471	G-187	G-471	G-623
Concept Beige solid 2 cm	G-9234	G-471	G-187	G-471	G-623

Adjustable system / Sistema de elevación : Plots



PLOT SR 13/22
PLOT SR 22/31

PLOT SR 06/10
PLOT SR 10/13

PLOT SNR 10
PLOT SNR 15

Class	Altura-Height	Ref.	Max. Weight
PLOT SNR10	10 mm	G-37	10000 Kg
PLOT SNR15	15 mm	G-37	6000 Kg
PLOT SR 6/10	65-100 mm	G-73	2500 Kg
PLOT SR 10/13	100-130 mm	G-79	2500 Kg
PLOT SR 13/22	130-220 mm	G-85	2200 Kg
PLOT SR 22/31	220-310 mm	G-99	2000 Kg

*Average plot quantity - 6 units / m²
*Cantidad de plots media - 6 units / m²

TECHNICAL CHARACTERISTICS CARACTERÍSTICAS TÉCNICAS	STANDARD TEST METHOD MÉTODO DE LA NORMA	STANDARD PRESCRIBED VALUES VALOR PRESCRITO POR LA NORMA	APAVISIA VALUE VALOR APAVISIA
MEASUREMENTS SURFACE APPEARANCE / DIMENSIONES Y ASPECTO SUPERFICIAL			
NOMINAL THICKNESS/ ESPESOR NOMINAL			2 cm
LENGTH AND WIDTH / LONGITUD Y ANCHURA	UNE - EN ISO 10545 - 2	+/- 0.6 % max	+/- 0.1 %
THICKNESS / ESPESOR	UNE - EN ISO 10545 - 2	+/- 5.0 % max	+/- 2.0 %
ORTHOGONALITY / ORTOGONALIDAD	UNE - EN ISO 10545 - 2	+/- 0.6 % max	+/- 0.2 %
SURFACE FLATNESS / PLANITUD DE SUPERFICIE	UNE - EN ISO 10545 - 2	+/- 0.5 % max	+/- 0.2 %
PHYSICAL PROPERTIES / PROPIEDADES FÍSICAS			
WATER ABSORPTION / ABSORCIÓN DE AGUA	UNE - EN ISO 10545 - 3	< 0.5 %	<0.1 %
BENDING RESISTANCE / RESISTENCIA A LA FLEXIÓN	UNE - EN ISO 10545 - 4	> 35 N/mm ²	>52 N/mm ² ***
BREAKING STRENGTH / FUERZA DE ROTURA	UNE - EN ISO 10545 - 4	< 1300 N	>4500 N ***
RESISTANCE TO SURFACE ABRASION / RESISTENCIA A LA ABRASIÓN SUPERFICIAL	UNE - EN ISO 10545 - 7	-	Class 4 *
TEMPERATURE SHOCK RESISTANCE / RESISTENCIA AL CHOQUE TERMICO	UNE - EN ISO 10545 - 9	NO SURFACE DEFECTS SHOULD BE VISIBLE No debe presentar defectos o roturas visibles	Resistant / Resistente
RESISTANCE TO COLD / RESISTENCIA A LA HELADA	UNE - EN ISO 10545 - 12	NO SURFACE DEFECTS OR CRACKS SHOULD BE VISIBLE No debe presentar defectos visibles	ANTI-ICE / Antihielo
ANTI-SLIP / ANTIDESLIZAMIENTO	DIN 51130	-	R11**
	DIN 51097	-	C**
	UNE - ENV 12633	-	Clase 3 **
	ASTM C 1028-96	> 0,6 DRY TEST / ENSAYO EN SECO	-
	BS EN 13036-4	-	>36 low slip potential **
COLOUR RESISTANCE TO LIGHT / RESISTENCIA DEL COLOR A LA LUZ	DIN 51094	THERE SHOULD BE NO COLOUR VARIATIONS No debe presentar defectos variaciones de color	NO ALTERATIONS
CHEMICAL PROPERTIES / PROPIEDADES QUÍMICAS			
CHEMICAL RESISTANCE / RESISTENCIA QUÍMICA	UNE - EN ISO 10545 - 13	RESISTANCE TO CHEMICAL PRODUCTS Resistencia a productos químicos	Min. GB
RESISTANCE TO STAINING / RESISTENCIA A LAS MANCHAS	UNE - EN ISO 10545 - 14		5

NAME / NOMBRE	SIZE / FORMATO	BOX / PALLET	PIECE / BOX	M ² /BOX	SQF / BOX	M ² / PALLET	SQF/ PALLET	KG / PALLET	KG / BOX	KG / PIECE
BASE 50x100	49,75 x 99,55 cm - 19.59" x 39.19"	36	1	0,5	0,15	17,83	5,33	880,00	23,89	23,59
DRAIN 25x100	24,51 x 99,55 cm - 9.65" x 39.19"	36	2	0,49	0,15	17,56	5,25	586,58	23,24	11,62
DRAIN ANGLE 25x25	24,51 x 24,51 cm - 9.65" x 9.65"	36	8	0,48	0,14	17,29	5,17	843,55	22,28	2,86

Special pieces measurements / Medidas pieza especial

*Dimensions in cm / Dimensiones en cm

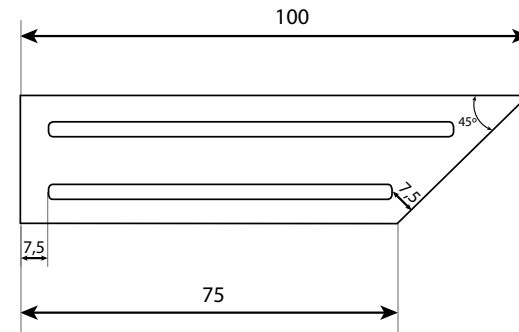
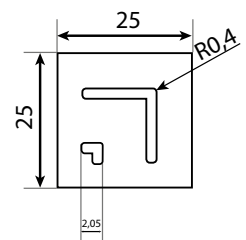
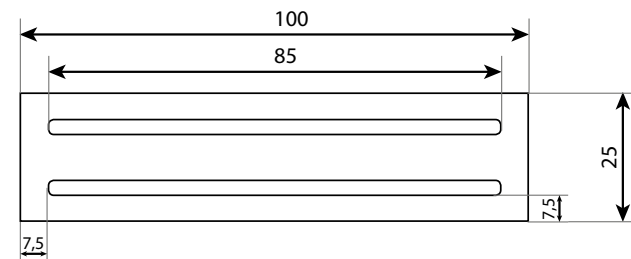
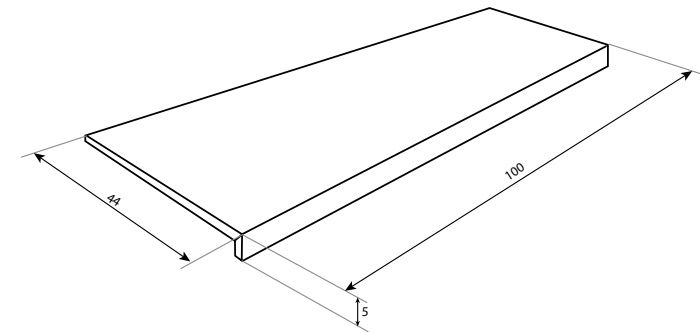

*Tests done in Regeneration grey solid 2 cm 50x100. Average test result value on March 2017. Consult specific product test result value before supplying.

**Pruebas realizadas sobre el producto Regeneration grey solid 2 cm 50x100. Valor de media a fecha de Marzo 2017. Consultar valor de un producto específico antes del suministro.

***Tests done in Regeneration grey solid 2 cm 50x100. Average test result value on March 2017. Consult specific product test result value before supplying.

***Pruebas realizadas sobre el producto Regeneration grey solid 2 cm 50x100. Valor de media a fecha de Marzo 2017. Consultar valor de un producto específico antes del suministro.

*** Average value. Test issued in Apavisia internal laboratory on Regeneration white solid 2 cm 50x100 on March 2017.

For any official certification or verification of the values listed, contact the Technical Department through dpto.tecnico@apavisia.com /

***Valor de media. Prueba realizada en laboratorio interno de Apavisia sobre el producto Regeneration grey solid 2 cm 50x100 a fecha de Marzo 2017.

Para cualquier certificación oficial o verificación de los valores mencionados contactar con el Departamento Técnico de Apavisia a través de dpto.tecnico@apavisia.com.

GENERAL CONDITIONS OF SALE

1. REGULATIONS FOR CONTRACTING

The general conditions of sale here detailed, except for any possible modifications or exceptions agreed in writing, shall govern all sale contracts concluded between APAVISA PORCELANICO S.L (hereinafter the Seller) and the Buyer. Any variations of the general conditions of sale, offers, transactions, credits or discounts, agreed by the Agents or other intermediaries of the Seller, will not be considered valid without the written confirmation of staff at the Seller's Head Office.

2. PURCHASE AND SUPPLY ORDERS

Only purchase orders received in writing will be valid, these being subject to the acceptance of the Seller by Order Confirmation. The supply shall include only the services, materials and quantities specified in the Order Confirmation or in other written communications by the Seller.

Should there be any differences in the request for order or Purchase Order, the Order Confirmation or pro forma invoice is to be considered the only valid document. A Partial Confirmation of the Order communicated in writing by the Seller means that the approval is partial and does not entail or imply confirmation of the rest of the requested order.

3. DELIVERY

Unless expressly agreed otherwise, the place of loading and the terms of sale of the Seller shall be indicated in the invoice and the delivery conditions will be "Ex Works" according to the INCOTERMS rules of the International Chamber of Commerce.

In any case, the full responsibility for deterioration, breakage or loss of product during the loading and transportation shall be borne by the Buyer.

The buyer must verify the integrity of the merchandise within a maximum period of 24 hours from receipt. Any broken or missing material communicated subsequently shall be understood as neither attributable to nor the responsibility of the Seller.

The costs for the return of the merchandise due to any errors or causes beyond the responsibility or control of the Seller, shall be fully borne by the Buyer.

4. DELIVERY TERMS

The delivery term shall be agreed by the contracting parties. Provided that special clauses have not been included, the delivery term will be for information purposes only and will not be understood as mandatory or a binding condition.

Any event of force majeure will interrupt the delivery term while the event lasts. If, as a result of force majeure, the contract cannot be executed within 60 days of the date agreed upon, each party shall be entitled to terminate the contract. In such case, the declaration of termination must be sent to the other party by registered letter with return receipt within 10 days from the expiry of said period of 60 days, excluding any reciprocal rights to compensation or reparation of damages suffered.

5. PRICES AND PAYMENTS

The valid price will be established by the Seller' in the corresponding invoice.

The place of Payment is set at the Seller's registered address in Spain.

Payment shall be made in the manner and the terms established by the Seller in the invoice for the sale of the merchandise.

The delay in the payment of the invoices issued, even if it were partial, exceeding the agreed maturity, will immediately accrue a default interest, calculated according to the legal interest of the money calculated annually in Spain with an increase of 6 basic points. In addition, the non-payment or delay in the payment of all or part of the invoices - whatever the reason - will entitle the Seller to request the advance payment for the outstanding supplies and / or to proceed with the termination of the contract, which will release the latter from the obligation to comply with other possible contractual obligations, and will be likewise entitled to cancel the supply of other possible pending orders, without the Buyer being able to request any type of compensation from the Seller.

6. GUARANTEE

The materials supplied meet the quality requirements established in the current standards EN-14411 and UNE-EN-ISO 10545. Quality assurance is limited to first quality materials, with a maximum allowable tolerance of approximately 5% (five percent). Any guarantee in respect of defects in second or third quality materials or special sale lots is expressly excluded.

Any claims for defects shall be necessarily notified by registered letter sent to the Seller's registered office, made before the material is mounted and, in any case, within 10 days from receipt of the material.

Any claims of installed material will not be accepted. Any claims for visible or hidden defects will not be valid once the material has been installed and the Guarantee will be automatically invalidated. It is the Buyer's responsibility to check that the material is in perfect condition before installing it.

The Guarantee includes only the cleaning and / or repair of material and, failing that, the return of the material with manufacturing defects, which do not comply with the current technical standards EN-14411 and UNE-EN-ISO 10545, excluding any other obligation of the Seller. The Quality Guarantee will cover any defects of the material, exclusively when these are derived from the manufacturing process. Likewise, the Seller is exempt from liability arising from any deficiencies or defects of the product due to other causes, besides the manufacturing process.

Any possible claims on the material will not give the Buyer any right to interrupt or delay, totally or partially, the payment that will have to be made within the established deadlines.

7. ARBITRATION CLAUSE

Any dispute arising in respect of the product of the Seller and the guarantee thereof, including, without limitation, any damages that are not solved amicably between the parties, shall be submitted to arbitration. The arbitration proceedings will be held before an arbitrator. The arbitration proceedings will be conducted in accordance with the rules and regulations of the Court of Arbitration, located in the Chamber of Commerce of Castellón (Spain). All parties unconditionally accept the provisions of this paragraph.

8. PROHIBITION TO EXPORT

Except in the case of other specific agreements, the Buyer shall not export the materials supplied by our Company, or transfer them to any companies or individuals for the purpose of exportation.

9. VALIDITY OF GENERAL CONDITIONS OF SALE

The aforementioned general conditions of sale are an integral part of the sale agreement and to all effects are binding for the Seller and the Buyer, moreover they faithfully represent the contractual will of the parties. The Buyer declares his specific approval. The confirmation of the Order or Pro forma invoice by the Buyer, implies the acceptance of the general conditions of sale.

CONDICIONES GENERALES DE VENTA

1. REGLAMENTACIÓN PARA CONTRATAR

Las condiciones generales de venta aquí detalladas, excepto las posibles modificaciones o excepciones acordadas por escrito, regirán todos los contratos de venta celebrados entre APAVISA PORCELANICO S.L (en adelante, el Vendedor) y el Comprador. Cualquier variación de las condiciones generales de venta, ofertas, transacciones, créditos o descuentos, acordados por los Agentes u otros intermediarios del Vendedor, no se considerarán válidos sin la confirmación por escrito del personal de la Oficina Central del Vendedor.

2. PEDIDOS DE COMPRA Y SUMINISTRO

Solo las órdenes de compra recibidas por escrito serán válidas, y estarán sujetas a la aceptación del Vendedor mediante la Confirmación de la Orden. El suministro incluirá solo los servicios, materiales y cantidades especificados en la Confirmación del pedido o en otras comunicaciones escritas por parte del Vendedor. Si hubiera alguna diferencia en la solicitud de pedido o en la Orden de compra, la confirmación del pedido o la factura pro forma se considerarán el único documento válido. Una confirmación parcial del pedido comunicada por escrito por el vendedor significa que la aprobación es parcial y no implica ni implica la confirmación del resto del pedido solicitado.

3. ENTREGA

A menos que se acuerde expresamente lo contrario, el lugar de carga y los términos de venta del Vendedor se indicarán en la factura y las condiciones de entrega serán "Ex Works" de acuerdo con las reglas de INCOTERMS de la Cámara de Comercio Internacional. En cualquier caso, la responsabilidad total por el deterioro, rotura o pérdida del producto durante la carga y el transporte correrá a cargo del Comprador. El comprador debe verificar la integridad de la mercancía dentro de un período máximo de 24 horas desde la recepción. Cualquier material roto o faltante comunicado posteriormente se entenderá como no atribuible ni responsabilidad del Vendedor. Los costos de la devolución de la mercancía debido a cualquier error o causas ajenas a la responsabilidad o control del Vendedor, correrán a cargo del Comprador.

4. TÉRMINOS DE ENTREGA

El plazo de entrega será acordado por las partes contratantes. Siempre que no se hayan incluido cláusulas especiales, el plazo de entrega será solo para fines informativos y no se entenderá como obligatorio ni obligatorio. Cualquier evento de fuerza mayor interrumpirá el plazo de entrega mientras dure el evento. Si, como resultado de fuerza mayor, el contrato no puede ejecutarse dentro de los 60 días de la fecha acordada, cada parte tendrá derecho a rescindir el contrato. En tal caso, la declaración de terminación debe enviarse a la otra parte por carta certificada con acuse de recibo dentro de los 10 días posteriores a la expiración de dicho período de 60 días, excluyendo cualquier derecho recíproco de compensación o reparación de daños sufridos.

5. PRECIOS Y PAGOS

El precio válido será establecido por el Vendedor en la factura correspondiente. El lugar de pago se establece en la dirección registrada del vendedor en España. El pago se realizará de la manera y los términos establecidos por el Vendedor en la factura por la venta de la mercancía. El retraso en el pago de las facturas emitidas, incluso si fuera parcial, superando el vencimiento acordado, devengará inmediatamente un interés de demora, calculado de acuerdo con el interés legal del dinero calculado anualmente en España con un aumento de 6 puntos básicos. Además, la falta de pago o la demora en el pago de la totalidad o parte de las facturas, sea cual sea el motivo, dará derecho al Vendedor a solicitar el pago por adelantado de los suministros pendientes y / o proceder con la terminación del contrato, que eximirá a este último de la obligación de cumplir con otras posibles obligaciones contractuales, y también tendrá derecho a cancelar el suministro de otros posibles pedidos pendientes, sin que el Comprador pueda solicitar ningún tipo de compensación al Vendedor.

6. GARANTÍA

Los materiales suministrados cumplen los requisitos de calidad establecidos en las normas actuales EN-14411 y UNE-EN-ISO 10545. El aseguramiento de la calidad se limita a los materiales de primera calidad, con una tolerancia máxima permitida de aproximadamente el 5% (cinco por ciento). Se excluye expresamente cualquier garantía con respecto a defectos en materiales de segunda o tercera calidad o lotes de venta especial. Cualquier reclamo por defectos se notificará necesariamente mediante una carta certificada enviada a la oficina registrada del Vendedor, hecha antes de que se monte el material y, en cualquier caso, dentro de los 10 días posteriores a la recepción del material. No se aceptarán reclamaciones de material instalado. Cualquier reclamo por defectos visibles u ocultos no será válido una vez que se haya instalado el material y la Garantía se invalidará automáticamente. Es responsabilidad del Comprador verificar que el material esté en perfectas condiciones antes de instalarlo. La Garantía incluye solo la limpieza y / o reparación de material y, en su defecto, la devolución del material con defectos de fabricación, que no cumplan con las normas técnicas actuales EN-14411 y UNE-EN-ISO 10545, excluyendo cualquier otra obligación del vendedor. La Garantía de Calidad cubrirá cualquier defecto del material, exclusivamente cuando se derive del proceso de fabricación. Asimismo, el Vendedor está exento de responsabilidad derivada de cualquier deficiencia o defecto del producto debido a otras causas, además del proceso de fabricación. Cualquier posible reclamo sobre el material no le dará al Comprador ningún derecho de interrumpir o retrasar, total o parcialmente, el pago que deberá realizarse dentro de los plazos establecidos.

7. ARBITRAJE

Cualquier disputa que surja con respecto al producto del Vendedor y la garantía del mismo, incluidos, entre otros, los daños que no se resuelvan amigablemente entre las partes, se someterán a arbitraje. El procedimiento de arbitraje se llevará a cabo ante un árbitro. Los procedimientos de arbitraje se llevarán a cabo de conformidad con las normas y reglamentos de la Corte de Arbitraje, ubicada en la Cámara de Comercio de Castellón (España). Todas las partes aceptan incondicionalmente las disposiciones de este párrafo.

8. PROHIBICIÓN A LA EXPORTACIÓN

Excepto en el caso de otros acuerdos específicos, el Comprador no exportará los materiales suministrados por nuestra Compañía, ni los transferirá a ninguna compañía o individuo con el propósito de exportarlos.

9. VALIDEZ DE LAS CONDICIONES GENERALES DE VENTA

Las condiciones generales de venta mencionadas anteriormente son una parte integral del acuerdo de venta y, a todos los efectos, son vinculantes para el Vendedor y el Comprador, además representan fielmente la voluntad contractual de las partes. El comprador declara su aprobación específica. La confirmación del pedido o factura pro forma por parte del comprador implica la aceptación de las condiciones generales de venta.



APAVISA
www.apavisa.com

APAVISA PORCELANICO S.L. assumes no liability for any printing errors. The technical characteristics contained in this catalog are mean values of our products. To carry out any orders that are requested consultations with the technical characteristics of the particular model to APAVISA PORCELANICO S.L.

All features and specifications are based on information available at the time of printing this catalog and may be changed without notice, according to market conditions, technological innovations and / or any other factor, without incurring any liability.

APAVISA PORCELANICO S.L. no asume ninguna responsabilidad por posibles errores de impresión. Las características técnicas que constan en el presente catálogo son valores medios de nuestros productos. Para la realización de cualquier pedido se solicita que sean consultadas las características técnicas del modelo en concreto a APAVISA PORCELANICO S.L. Todas las características y especificaciones técnicas están basadas en la información disponible en el momento de la impresión del presente catálogo y podrán ser modificadas sin previo aviso, de acuerdo a las circunstancias del mercado, innovaciones tecnológicas y/o cualquier otro factor, sin incurrir en ningún tipo de responsabilidad.

SOLID
2 cm

APAVISA
www.apavisa.com

Ctra. Castellón – San Juan de Moró, hm.7,5 - 12130 SAN JUAN DE MORÓ (Castellón) Spain
Tel. +34 964 701 120 - Export Fax +34 964 701 067 - Fax Nacional 964 701 195 - info@apavisa.com

